

# PRODUCT INFORMATION

## **TAKASAGO** **Fluidic Systems** **2021 24p**

Customization  
Miniaturization  
Integration

**Takasago Fluidic Systems**



# Health

## For the well-being of mankind

We want our products to be used in devices that are used to improve people's health and happiness. e.g. in blood analyzers, dialysis machines and other medical / diagnostic applications.

# Environment

## Preserve clean air and water for future generations

Our products are installed into many kinds of environment-related applications like water quality analyzers, automotive emissions etc. to help protect the environment.

# Technology

## Small, Fast, Highly Accurate

We, as a high-tech fluidic control system manufacturer, always aim to achieve the most advanced technological standards.

The core strengths of Takasago Fluidic Systems (TFS) are customization, miniaturization, and integration. With these, TFS is recognized in the industry as a distinctive player that fulfills the niche demands of its clients. For instance, we offer the world's smallest class of products to handle fluid volumes in the microliter order without waste. As a result, we not only supply parts to major global analytical equipment manufacturers but also get involved in technically demanding projects lead by well-known universities and agencies such as Harvard, Stanford, MIT, and Cambridge as well as NASA and JAXA.



## 1 Customization

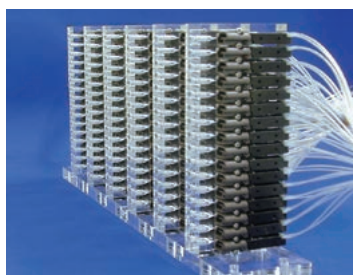

- Custom fluidic configurations
- Fluidic optimizations
- Component development
- Special fluidic/electrical interface

## 2 Miniaturization

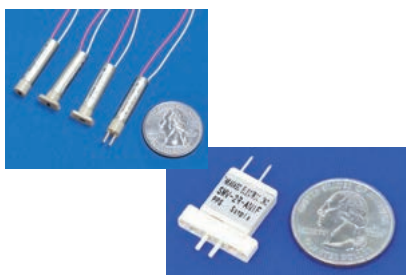

- Miniaturizing instrument
- Minimizing sample volume
- Faster operation / higher accuracy

## 3 Integration

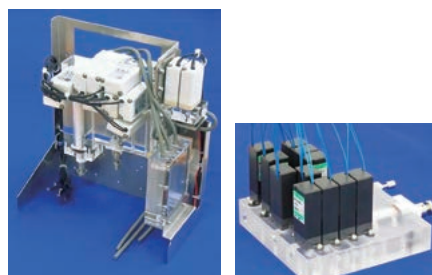

- Integrating various fluidic components
- Offering functional systems
- Minimizing the total footprint

Having developed in excess of 10,000 different valves over 60 years, Takasago Fluidic Systems has established itself as a leading manufacturer of valves and other fluidic devices. With this experience and knowledge about fluid-handling and precision control, we can provide our customers with high quality custom-made products. The products listed in this brochure represent only a small part of our product range. Various applications of our products include :

Diagnostic instruments such as clinical chemistry/immunoassay analyzers
Environmental measuring instruments for water, air, flue gas or automotive exhaust gas
Analytical instruments including liquid/gas chromatographs
Medical instruments including dialysis machines
Biotechnology equipment for DNA analysis, cell culture, cell handling, etc.
Semiconductor and LCD manufacturing equipment
Ink-jet printers
Fluid control devices for beverages, etc.
Other devices.

## CONTENTS

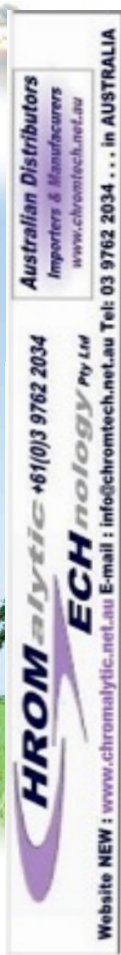
- |   |   |
|---|---|
| <ul style="list-style-type: none"> <li>■ <b>Innovatively Small and Highly Functional : Miniature Isolation Valves</b> p. 4/p. 5           <ul style="list-style-type: none"> <li>• NV/NLV Series</li> <li>• KV Series</li> <li>• EXAK Series</li> <li>• Miniature Isolation Valves</li> <li>• EXAKN Series</li> <li>• WTE Series</li> <li>• EXV Series</li> <li>• Pumping Volume</li> </ul> </li> <li>■ <b>Diaphragm Valves with High Reliability and Outstanding Inertness</b> p. 6/p. 7           <ul style="list-style-type: none"> <li>• STV/CTV Series</li> <li>• MTV Series</li> <li>• Soft-seal</li> <li>• High-temperature High-puressure Valve</li> <li>• PKV Series</li> <li>• Zero-internal-volume Design</li> </ul> </li> <li>■ <b>General Overview of Solenoid Valves and Power Saving Items</b> p. 8           <ul style="list-style-type: none"> <li>• General Overview of Solenoid Valves</li> <li>• Latching Solenoid Valves</li> </ul> </li> <li>■ <b>Isolation Valves with Universal Pressure Rating</b> p. 9           <ul style="list-style-type: none"> <li>• Bellows Isolation Valve WBV Series</li> <li>• O-ring Isolation Valve WEG Series</li> <li>• Rocker Isolation Valve RVB Series</li> </ul> </li> <li>■ <b>Slider valves, Proportional valves and Pressure Relief Valves</b> p. 10/p. 11           <ul style="list-style-type: none"> <li>• Solenoid-driven Slider Valves</li> <li>• 2-Position 6-Port Valve</li> <li>• Proportional Diaphragm Valve NPV/WPN Series</li> <li>• Relief Valves CIV/CMV Series</li> <li>• Cartridge Type Solenoid Valve</li> </ul> </li> <li>■ <b>Various Unique Products</b> p. 12/p. 13           <ul style="list-style-type: none"> <li>• Air Operated Valves</li> <li>• Non Diaphragm Valves UDV series</li> <li>• Holding Voltage and "Hit &amp; Hold" Circuit</li> <li>• Shape Memory Alloy Valve SMV Series</li> <li>• Molded Manifold Valve XTA Series</li> <li>• Push-in Fitting Diaphragm Valve</li> <li>• Micro Needle Valve MNV Series</li> </ul> </li> <li>■ <b>Manifold Products and Pinch Valves</b> p. 14/p. 15           <ul style="list-style-type: none"> <li>• Standard Manifolds</li> <li>• Custom Manifolds</li> <li>• Multi-layer Bonded Manifold</li> <li>• Bonded PTFE Manifold</li> <li>• Pinch Valves</li> <li>• Molded Quaternary Valve</li> <li>• Chemically Inert Pinch Valve</li> </ul> </li> <li>■ <b>Micro Pumps for Infusion Drug Delivery Systems</b> p. 16/p. 17           <ul style="list-style-type: none"> <li>• Ultra-small Peristaltic Pump BCP/RCP Series</li> <li>• Piezoelectric Micro Pumps</li> <li>• Chip Pump ACP/QCP Series</li> <li>• SMP Series</li> <li>• Electro-osmotic Micro Pump EBP Series</li> </ul> </li> <li>■ <b>Pumps Covers wide range of Flow Rate</b> p. 18/p. 19           <ul style="list-style-type: none"> <li>• Tubing Pump RP-TX Series</li> <li>• Tubing Pump RP-Q II /Q III Series</li> <li>• Tubing Pump RP-HX Series</li> <li>• Tubing Pump RP-G III Series</li> <li>• Pen Type Syringe Pump SBP Series</li> <li>• Palmtop Size Syringe Pump SCP Series</li> <li>• Metering Pumps</li> <li>• Diaphragm Pump DBP Series</li> </ul> </li> <li>■ <b>Disposable Chips and Pump Unit</b> p. 20/p. 21           <ul style="list-style-type: none"> <li>• Microfluidic Chips</li> <li>• Reagent-prefillable Disposable Fluidic Systems<br/>(●Roller Pump Type, ●Syringe Pump Type)</li> <li>• EOP-Driven Micro Pumping Unit</li> <li>• Manually Adjustable Low Pulsation Micro Pump Unit</li> <li>• Smart Dispensing Module</li> <li>• Sample Injector Module</li> </ul> </li> <li>■ <b>Bio / Life Science and Aerospace</b> p. 22/p. 23           <ul style="list-style-type: none"> <li>• Portable Medium Replacement System</li> <li>• Micro 3D Perfusion Culture System</li> <li>• All-in-one Disposable PDMS Chip</li> <li>• 6-channel Pump</li> <li>• Live Cell Imaging Fluidic System</li> <li>• Differentiation Induction System</li> <li>• Valves for Satellite Propulsion System HVA/HVC/HVD Series</li> </ul> </li> </ul> |  |
|---|---|



# Innovatively Small and Highly Fun

## NV/NLV Series

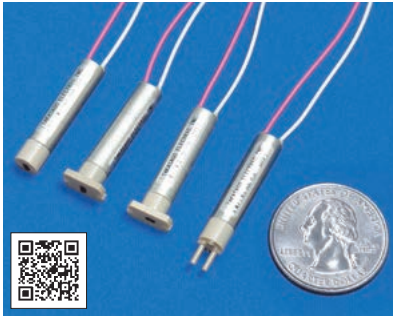

	NV Series	NLV Series
Dimensions	$\phi 5.7 \times H 27$ mm (excluding mounting parts and barbs)*1	
Orifice Diameter	0.4 mm	
Port Connection	Barb, Gasket	
Pressure	0 - 100 kPa	
Voltage	5 VDC, 12 VDC	
Power Consumption	1.2 W	1.2 W (12 VDC) 1.4 W (5 VDC)

\*1 Dimensions of NV-2-NIF and NLV-2-NIF

## KV Series

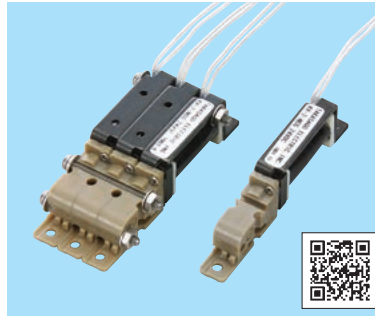

Dimensions	W 6 × L 50 × H 12.5 mm
Orifice Diameter	0.8 mm
Port Connection	O-ring
Pressure	0 - 100 kPa
Voltage	12 VDC, 24 VDC
Power Consumption	1.8 W

## EXAK Series



Dimensions	$\phi 12 \times H 48.1$ mm
Orifice Diameter	0.8 mm
Port Connection	Barb, M5
Pressure	-40 - 100 kPa
Voltage	12 VDC, 24 VDC
Power Consumption	0.94 W

## Miniature Isolation Valves

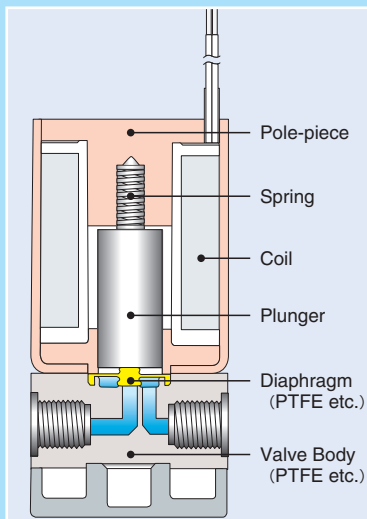

Our solenoid valve consists of two sections ; one is the valve part made of highly inert plastics like PTFE or PEEK, which opens and closes a flow path. The other is the actuator made of a coil and metallic parts, driving the valve part. In order to preserve the purity of the fluid, a diaphragm is installed between the two sections in our isolation valves. The diaphragm prevents the fluids from flowing into the actuator and protects the metallic parts from being corroded. Also, metal dust generated in the actuator does not contaminate the fluid. This structure is ideal for analytical and diagnostic applications which are sensitive to particles. It is also suitable for handling acids and chemicals which erode metals.

By reducing the size of these isolation valves, we have been able to reduce the dead volume, improve the control of the pumping volume, and reduce the installation area, thereby improving accuracy and avoiding wasting chemicals and solvents.

# Functional : Miniature Isolation Valves

## EXAKN Series



Dimensions	W 18 × L 18.6 × H 44 / $\phi$ 14 × H 42.3 mm
Orifice Diameter	0.8 mm
Port Connection	Gasket, M5, Barb
Pressure	- 40 - 300 kPa
Voltage	12 VDC, 24 VDC
Power Consumption	1.2 W

This micro solenoid diaphragm isolation valve, the EXAKN series is a zero-pumping volume-type of diaphragm isolation valve. FFKM is used for the seal part and with this the valve has an increased sealing ability. The outer dimensions of this valve are very compact at only  $\phi$ 14.0 x H 42.3 mm (Barb).

## WTE Series



Dimensions	W 19 × L 11 × H 31.3 mm
Orifice Diameter	1 mm
Port Connection	Gasket
Pressure	- 65 - 100 kPa
Voltage	12 VDC, 24 VDC
Power Consumption	1.5 W

## EXV Series

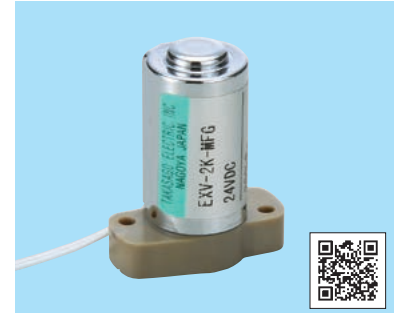

Dimensions	W 14 × L 25.0 × H 31.7 mm
Orifice Diameter	1 mm
Port Connection	Gasket
Pressure	- 50 - 200 kPa
Voltage	12 VDC, 24 VDC
Power Consumption	2.8 W

## Pumping Volume

The diaphragm produces a pumping effect on the fluid as the valve opens and closes. As some valve models pump several microliters of fluid at one time, the pumping volume forms a negative factor in metering an accurate fluid volume, and also in preventing fluid from dripping from a dispensing nozzle.

Some of the valve models we provide have remarkably small pumping volumes due to their unique internal structures or miniaturized dimensions. The EXAK series has a distinctive design called a "zero-pumping-volume structure" that allows the pumping volume to run 100 times smaller than our standard valves. Rocker valves (page 8) and non-diaphragm inert valves (made of inert materials like stainless steel) have very small pumping volumes due to no volumetric change in the valve chamber during an operation. We also provide slider valves (page 12) with pumping volumes that have been ultimately reduced to an immeasurable level.

unit:  $\mu$ l

TYPE	PORT	ON-1	OFF-1	ON-2	OFF-2	ON-3	OFF-3
Zero-pumping-volume type (EXAK-3)	COM.	0.002	-0.015	0.002	-0.015	0.002	-0.015
	N.C.	0.024	-0.01	0.024	-0.01	0.024	-0.01
	N.O.	0.005	-0.005	0.005	-0.005	0.005	-0.005
Rocker solenoid type (Low pumping volume model)	COM.	0	0	0	0	0	0
	N.C.	0.103	-0.18	0.137	-0.263	0.145	-0.213
	N.O.	-0.059	0.103	-0.027	0.025	-0.033	0.027
Non-diaphragm valve	IN	-0.009	0.018	-0.018	0.009	-0.017	0.018
	OUT	-0.723	0.81	-0.71	0.826	-0.708	0.849
Conventional type (MTV-3R)	COM.	2.346	2.609	2.425	2.604	2.427	2.551
	N.C.	2.63	2.317	2.481	2.293	2.521	2.34
	N.O.	7.238	7.373	7.443	7.395	7.506	7.388

# Diaphragm Valves with High Re

## STV/CTV Series



	① STV Series	② CTV Series
Dimensions	φ20 × H 42.5 mm	φ21 × H 59.8 mm (excluding projection parts)
Orifice Diameter	1.2 mm	1.6 mm
Port Connection	M6, 1/4-28UNF, Barb, Push-in Fitting	
Pressure	- 50 - 200 kPa	
Voltage	12 VDC, 24 VDC	
Power Consumption	2.5 W	3.5 W

\* Manifold-mountable models are also available.

## MTV Series



Dimensions	φ26 × H 53.2 mm
Orifice Diameter	1.6 - 2 mm
Port Connection	M6, 1/4-28UNF, Barb
Pressure	- 90 - 300 kPa
Voltage	12 VDC, 24 VDC
Power Consumption	1.9 W, 2.6 W

\* Manifold-mountable models are also available.

## Soft-seal

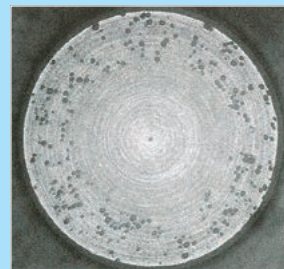
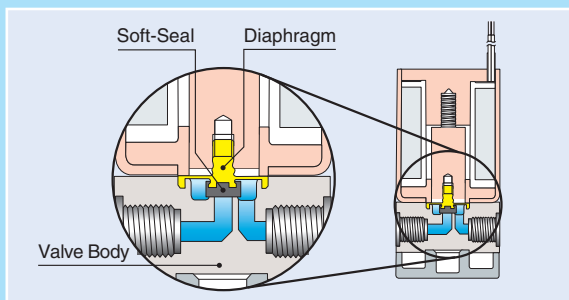

All-Teflon Diaphragm x20

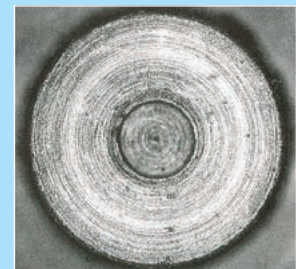

Soft-seal x20

Problems can arise with PTFE diaphragm valves when scratches on the seal part of the valve, due to dust or crystals in the fluid, cause the valve to leak. TFS offers an optional "Soft-seal" to protect the sealing surface from being scratched by covering it with perfluoroelastomer (FFKM), which is a special elastomer that has outstanding resistance to most chemicals and solvents. The chemical inertness of the FFKM is almost equal to PTFE. It has a high reputation for use with chemicals in analytical or semi-conductor industries. FKM is also available for the Soft-seal material. The photo shows the advantage of having glass beads of diameter 40μm, scattered on the valve seat in the active state. The scars due to the beads is on the fluoro polymer diaphragm and hence, its effect on the soft seal has been substantially reduced.

# liability and Outstanding Inertness

## High-temperature High-pressure Valve



	① MTV-2A	② WTB-2A
Dimensions	φ 25.3 × 47.7 mm	25.3 × 28.2 × 54.2 mm
Orifice Diameter	1.6 mm	
Port Connection	M6, 1/4-28UNF	
Pressure	0 - 1,500 kPa	
Voltage	12 VDC, 24 VDC	
Power Consumption	17.6 W (INRUSH) 2.9 W (HOLDING)*	16.8 W (INRUSH) 4.2 W (HOLDING)*
Fluid Temperature Range	5 - 175 °C	

\* With hit and hold circuit

## PKV Series



	① PKV-2	② PKV-3
Dimensions	W 43 × L 36 × H 71 mm	W 43 × L 36 × H 82 mm
Orifice Diameter	4 - 6 mm	
Port Connection	Rc1/8, Rc1/4, 1/8-27NPT, 1/4-18NPT, Barb (PKV-2 only)	
Pressure	- 50 - 200 kPa	- 50 - 100 kPa
Voltage	12 VDC, 24 VDC	
Power Consumption	6 W, 10 W	10 W

## Zero-internal-volume Design

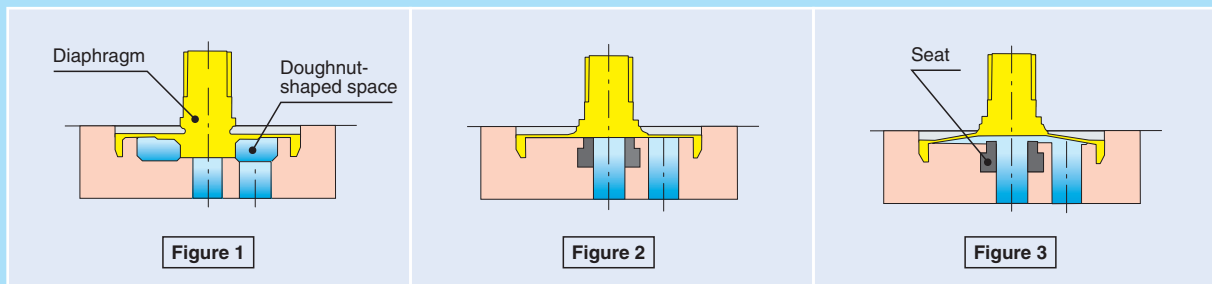

### ■ Applicable models

- STV Series (2-way type only)
- MTV Series
- MLV Series

A diaphragm solenoid valve normally has a doughnut-shaped space right under the diaphragm, through which fluids flow to the outlet port (Figure 1). This space, often called a "valve chamber", works as excess internal volume to waste solvents and samples. Fluids tend to stay in this dead space and therefore decrease the purity of each fluid. In addition, air bubbles may be trapped in this valve chamber and can have a negative effect on analytic accuracy. To conclude a valve chamber causes various undesirable results for applications. To overcome these problems, TFS has designed the Zero-Internal-Volume Valve, in which a special structure is employed to eliminate the valve chamber (Figure 2). On opening, the diaphragm is lifted and the space is formed for the fluid to stream (Figure 3).



# — General Overview of Solenoid Valves and Power Saving Items —

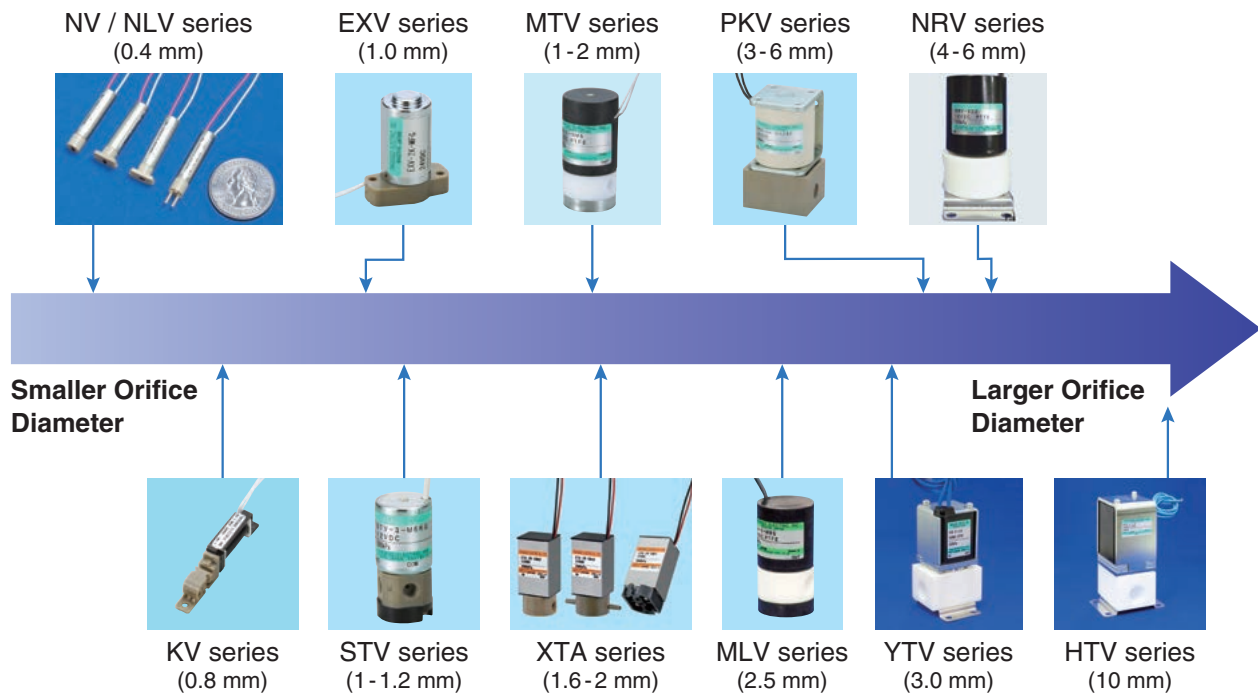

## Latching Solenoid Valves



For a conventional (e.g. N.C. - Normally Closed) solenoid valve, continuous energization is required to maintain open status. The latching solenoid does not require a power supply for the purpose of maintaining open status through the utilization of a permanent magnet. Suitable for applications where the power consumption and the effect of temperature on a fluid is a concern.



	Orifice Diameter or Tube Diameter	Valve Type
① NLV Series	0.4 mm	Diaphragm valve
② WLB Series	2 mm	Diaphragm valve
③ PL Series	1 × 3 mm, 3 × 5 mm	Pinch valve
④ EL Series	10 × 13 mm	Pinch valve

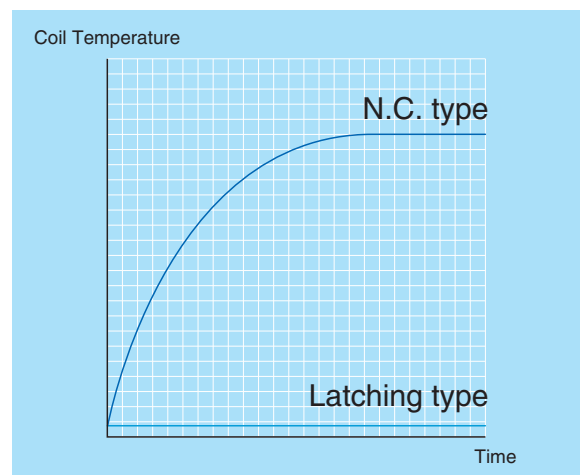



# — Isolation Valves with Universal Pressure Rating —

## Bellows Isolation Valve WBV Series



Internal structure optimised for a compact size with a larger flow (orifice dia. 4 mm) than conventional valves.

Dimensions	W 35 × L 33 × H 84.8 mm (excluding hose barbs)
Orifice Diameter	4 mm
Port Connection	Barbs on both sides, Barb on one side (O-ring on the other side)
Pressure	-90 - 300 kPa (Universal)
Fluid Temp. Range	5 - 95 °C
Voltage	12 VDC, 24 VDC
Power Consumption	6 W
Wetted Materials	PPS, FKM

## O-ring Isolation Valve WEG Series



Dimensions	W 21 × L 16 × H 54.4 mm (excluding mounting parts and barbs)
Orifice Diameter	2 mm
Port Connection	Hose Barb
Pressure	-90 - 200 kPa (Universal)
Voltage	12 VDC, 24 VDC
Power Consumption	2.6 W
Wetted Materials	PPS, FKM (Optionally EPDM)

Patented

## Rocker Isolation Valve RVB Series



- Ultra-low displacement volume due to no volumetric change in the valve chambers during operation.
- COM., N.C. and N.O. ports carry a uniform operating pressure, applicable in all directions. High pressure models (500 kPa) are optionally available.
- Valve width of 16 mm (gasket type) enables efficient mounting of rocker valves on a manifold.
- The TFS original mounting gasket footprint features minimized internal volume, and in addition, a universal gasket footprint option is also available.
- As 2-way valve options, type 21 features minimal carryover, using the NC and NO ports, while type 2 is designed for universal connection, using the COM and NO ports.

### Cross-sectional Image of Rocker Structure

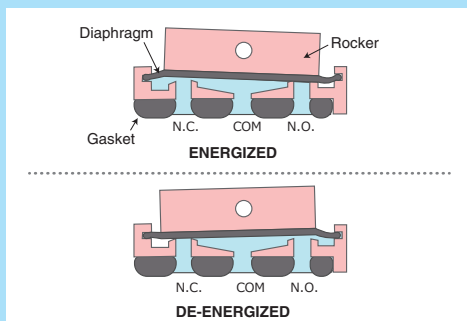

Dimensions	W 16 × L 27 × H 45.8 mm (excluding mounting parts.)
Orifice Diameter	1.6 mm
Port Connection	M6, 1/4-28UNF, Gasket
Pressure	-90 - 250 kPa (Universal)
Voltage	12 VDC, 24 VDC
Power Consumption	3.4 W

Patented

# Slider valves, Proportional valve

## Solenoid-driven Slider Valves

### ● 2-way (N.C.)

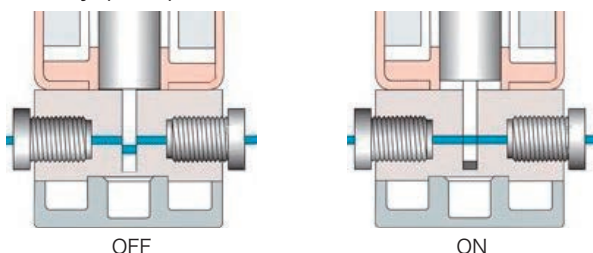

This is a kind of shear valve in which a shutter called a “slider” moves vertically and shuts off the flow path. The pumping volume\* and the dead volume are reduced to almost zero, preventing reduction of accuracy in analysis or fluid dispensation. It features an excellent fluid exchangeability compared to a diaphragm solenoid valve due to its almost linear flow path and very small internal volume.

\* Please refer to page 5 for more details on the pumping volume.

### ● 3-way

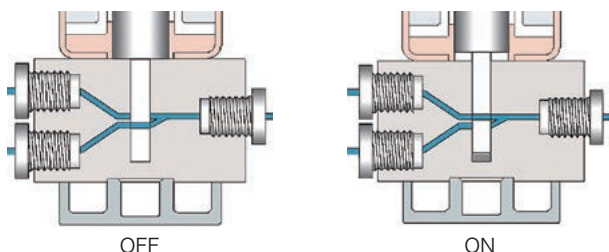

	MTV	NRV
Dimensions	W 39 × L 26 × H 62 mm	W 41 × L 38 × H 86 mm
Orifice Diameter	0.4 mm	1.0 mm
Port Connection	No. 10-32UNF	M6, 1/4-28UNF
Pressure	0 - 500 kPa	0 - 300 kPa
Voltage	12 VDC, 24 VDC	
Power Consumption*	18 W (intermittent : 45 s*)	16 W (intermittent : 2 min*)
Wetted Materials	PTFE, PEEK, AL <sub>2</sub> O <sub>3</sub>	PTFE, PEEK, SiC

\* Continuous operation possible with a “hit and hold” circuit (page 12)

Patented

### ■ Pumping Volume Comparison (Diaphragm Valve vs. Slider Valve)

(Flow rate at the N.C. port when turning a 3-way valve on/off)

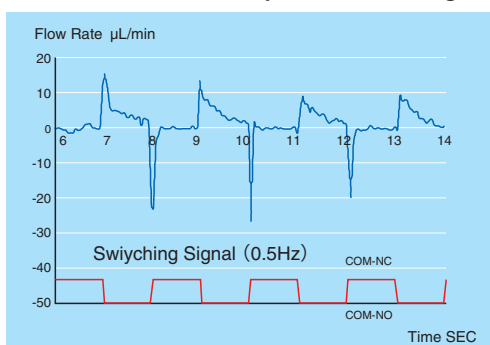

<Diaphragm Valve (KV-3K Series)>

These data are provided by Fujii T. Lab, Institute of Industrial Science, the University of Tokyo.

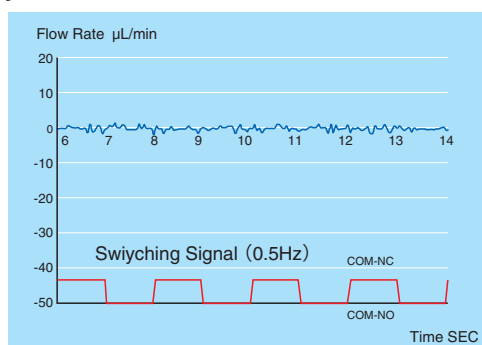

<Slider Valve (MTV-3SL Series)>

MTV



NRV



## 2-Position 6-Port Valve

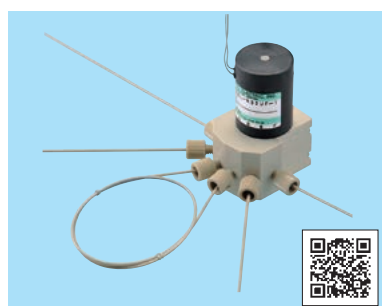

OFF

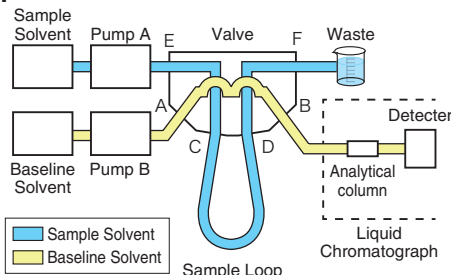

ON

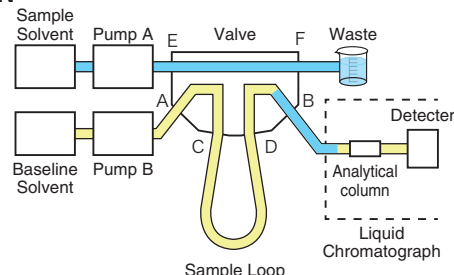

The valve in the photograph is a 2-position 6-port valve that employs the technology of a solenoid-driven slider valve. As the solenoid driven actuator requires no driver or external stepper motor, it is more economical and easier to operate than a conventional motor-driven rotary valve. It is suitable for sample metering/injection in a liquid chromatograph. A 2-position 4-port type injection valve is also available. Please consult with us for details.

# Valves and Pressure Relief Valves

## Proportional Diaphragm Valve NPV / WPN Series



- Solenoid driven proportional diaphragm valve
- Highly chemically resistant with PTFE as only wetted parts.
  - Flow rate is controllable by adjusting the input voltage.
  - Designed with larger orifice of 4.0 mm, to cover wide range of flow rates.
  - Capable of handling gases and liquids.



- Solenoid driven proportional diaphragm valve
- Larger orifice size option designed for applications such as ventilators.
  - Flow rate is controllable by adjusting the input voltage.
  - Capable of handling gases and liquids.

## Relief Valves CIV/CMV Series



- Custom Pressure Relief Valves
- Designed to help protect systems that may see rise in pressure.
  - CMV series has a simple flow path with metal being the wetted part for gas.
  - CIV series is designed for high corrosion resistance, with PTFE, PPS, and FFKM used as wetted parts.
  - Custom designed by pressure requirements, wetted materials, connections, orifice size, etc.

## Cartridge Type Solenoid Valve



- Detachable diaphragm Isolated solenoid valve
- Valve body is easily detached and attached by magnets.
  - Ideal for applications requiring high cleanliness, such as regenerative medicine.
  - Detachable valve body can be autoclaved.
  - Free tubing direction, with the valve body being rotatable.

Patent Pending

## Air Operated Valves



	① PDT	② PMDP
Dimensions	φ44.5 × H 52 - 67 mm	φ25 × H 42 - 49 mm
Orifice Diameter	3 - 5 mm	2 mm
Port Connection	Rc1/8, Rc1/4	M6, 1/4-28UNF, Barb
Operating Pressure	0 - 300 kPa	- 90 - 500 kPa
Port Connection for air pressure	Rc1/8	M5, M6, 1/4-28UNF
Air Pressure for actuation	300 - 600 kPa	300 - 600 kPa

## Non Diaphragm Valves UDV series



This the main model available among our non-diaphragm valves. This is a solenoid driven valve. The high pressure type is also available (600kPa).

	① UDV-2	② UDV-3
Dimensions	W 26 × L 22 × H 52.2 mm	W 26 × L 22 × H 58.7 mm
Orifice Diameter	2 mm	N.O. : 1.2 mm, N.C. : 1.5 mm
Port Connection	M6, 1/4-28UNF	COM, N.C. : M6, 1/4-28UNF N.O. : M5
IN Port Pressure	0~300 kPa	COM : 0 - 300 kPa
Voltage	12 VDC, 24 VDC	
Power Consumption	2.4 W	3.7 W

## Holding Voltage and “Hit & Hold” Circuit

Once switched to ON-position by energizing at the rated voltage, a solenoid valve can hold the ON-position status even after the applied voltage is dropped to a lower voltage. For example, in case that a 2-way normally closed valve with a rated voltage of 24 VDC is switched to ON-position, it can hold the ON-position even after the applied voltage is dropped to around 10 VDC (Holding Voltage). Using this characteristic, various benefits are achieved, such as low power consumption, reduction of coil heat-generation (see graph below), improvement of response time, increase of operating pressure, minimization of size, etc. This requires you to control the applied voltage. As an alternative to controlling the voltage at the equipment side we can offer you a “Hit & Hold” circuit, which can be simply attached to a valve. This circuit automatically drops the applied voltage to a lower value after a very short period of time (Inrush Time).

Coil Temperature

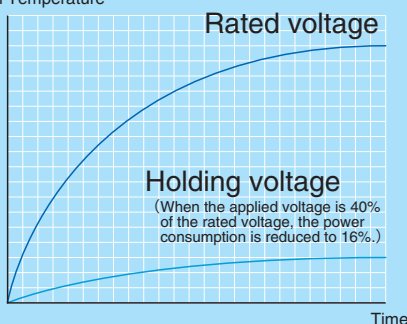

### Standard specifications of our “Hit & Hold” circuit

Input	5 VDC - 27 VDC
Inrush Time	100 ms, 300 ms
Output	40 % of Input (after Inrush Time)

### Dimensions

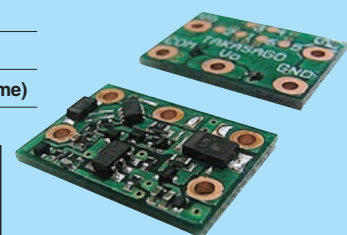
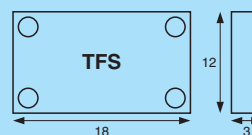



# que Products

## Shape Memory Alloy Valve SMV Series

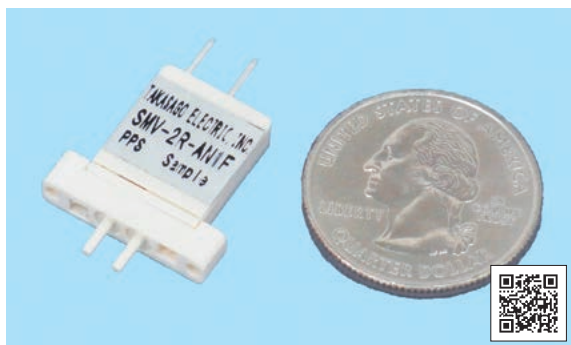

### Shape Memory Alloy Valve

- Compact, lightweight, low power consumption, and quiet actuations.
- Low cost, which is beneficial for applications requiring disposable valves.

Patented

Dimensions	W 19 × L 18.4 × t 4 <sup>*1</sup> mm
Orifice Diameter	0.4, 0.8 mm
Response Time	Approx. 600 ms (at 30 °C) <sup>*2</sup>
Power Consumption	0.3 W or less (Constant current operation)
Operating Temp. Range	5 - 40 °C

\*1 Excluding pin terminals and barbs

\*2 Response times vary depending on the ambient temperature.

Can be improved by controlling the applied current e.x. PWM, a spike & hold circuit, etc. Please contact us for details.

## Molded Manifold Valve XTA Series

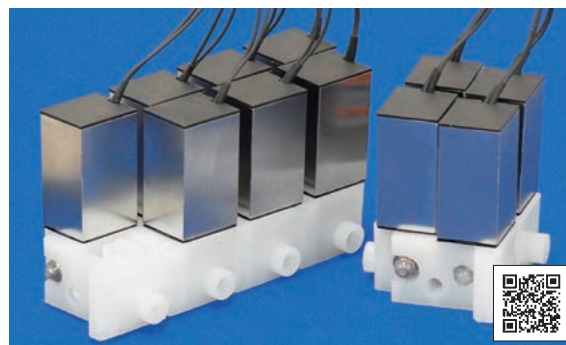

Each basic block holds a pair of 2-way valves. Up to 6 blocks can be flexibly joined together to give a maximum of 12 stations. This manifold provides both a cost reduction and a flexible configuration that cannot be achieved by conventional molded manifolds.

A 2-row construction enables a shorter length of manifold and a common channel, which contributes to a small internal volume and easy arrangement on an instrument.

The extremely inert material ETFE (fluorocarbon polymer) is used for the block.

Orifice Diameter	1.6 mm
Port Connection	M6, 1/4-28UNF, Push-In Fitting*
Pressure	-90 - 200 kPa
Voltage	12 VDC, 24 VDC
Power Consumption	2.8 W
Wetted Materials	ETFE, PTFE, FFKM (Optionally FKM, EPDM)

## Push-in Fitting Diaphragm Valve



- Just insert plastic tubing into ports and you are connected. No special preparation of the tubing is required, such as enlarging the connection end.
- For disconnection, simply pull out the tubing while pushing in the port ends.
- Applicable to O.D. 2 mm PTFE/PFA tubing.
- High chemical resistance due to PPS, FPM and PTFE wetted materials.
- Integral molding eliminates the concern of leakage between the fittings and the body.

## Micro Needle Valve MNV Series



### < Example Flow Data\* >

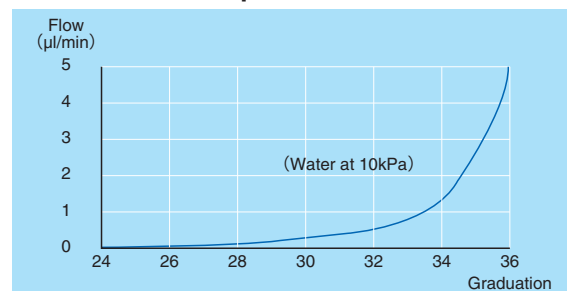

\* Flow-graduation relationship varies according to valve.

- Allows the adjustment of flows below 1 µl/min.
- Reduces flow pulsation.
- Only Perfluoroelastomer and PEEK as the wetted materials. (The pipe insert type includes stainless steel.)

# Manifold Products

## Standard Manifolds

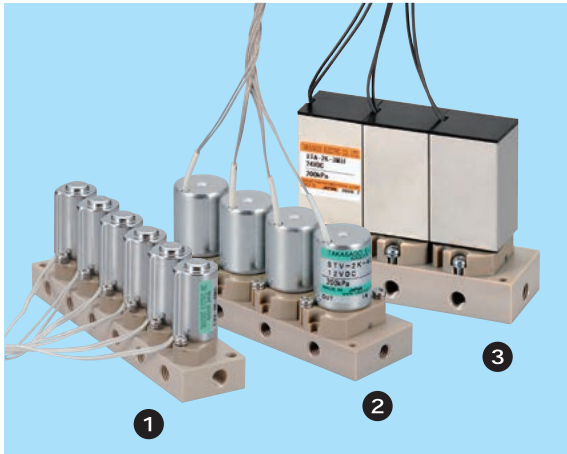

	① EXV Series	② STV Series	③ XTA Series
Orifice Diameter	1 mm	1.2 mm	2 mm
Port Connection	M6, 1/4-28UNF		
Pressure	-20 - 200 kPa	-50 - 200 kPa	-50 - 200 kPa
Voltage	12 VDC, 24 VDC		
Power Consumption	2.8 W x (No. of valve)	2.5 W x (No. of valve)	2.8 W x (No. of valve)
Max. number of valves	6		

## Custom Manifolds

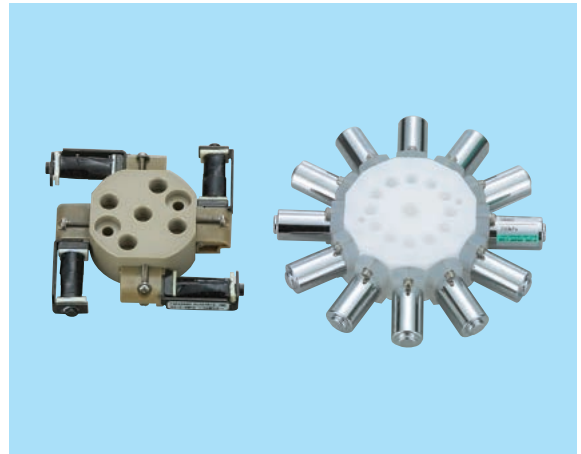

For applications requiring compact valve alignment and/or short flow-paths, manifold would be the best option. Takasago is capable of helping design and machine custom manifolds that meet your flow diagram requirements. Manifolds can be made in different shapes, sizes, and materials, and we are also capable of integrating the manifold with components such as pumps.

## Multi-layer Bonded Manifold



## Bonded PTFE Manifold



These multi-layer manifolds are made by bonding layers that have channels engraved on the surface. The result is a highly integrated manifold with freely curving channels that could not be fabricated through a conventional drilling process. The bonding process does not use any adhesive in order to utilize the pure characteristics of each material. Materials available are PMMA, PC, ULTEM®, etc. Only TFS works with PTFE, the material with a very high chemical compatibility, in this way.

# and Pinch Valves

## Pinch Valves



We have valves of various sizes both, solenoid actuated and air driven.

	① PE Series	② PSK Series	③ PMK Series	④ PK Series	⑤ NP Series	⑥ PPK Series	⑦ EPK Series
Method	Solenoid	Solenoid	Solenoid	Solenoid	Solenoid	Air*	Solenoid
Dimensions	φ14 × H 55.1 mm	φ20 × H 51 mm	φ26 × H 61.5 mm	W 40 × L 36 × H 65 - 88.3 mm	W 40 × L 36 × H 65 - 88.3 mm	W 50 × L 60 × H 92 mm	φ64 × H 112 - 132 mm
Tube Material	Silicone	Silicone, PharMed®	Silicone, PharMed®	Silicone	Silicone	Silicone	Silicone
Tube Diameter	0.8 × 2.4 mm	1 × 3 mm 1.6 × 3.2 mm	0.8 × 2.4 mm 1 × 3 mm	3 × 5 mm 6 × 8 mm	3 × 5 mm 6 × 8 mm	7 × 12 mm	10 × 13 mm 15 × 19 mm
Discharge Pressure	0 - 100 kPa	0 - 150 kPa	0 - 150 kPa	0 - 50 kPa	0 - 50 kPa	0 - 50 kPa	0 - 50 kPa
Voltage	12 VDC, 24 VDC	12 VDC, 24 VDC	12 VDC, 24 VDC, 100 VAC	12 VDC, 24 VDC, 100 VAC	12 VDC, 24 VDC, 100 VAC	—	12 VDC, 24 VDC, 100 VAC
Power Consumption	2.8 W	3 W	4.4 W	10 W	10 W	—	60 W (intermittent : 5 min.)

\* Operating Pressure Range : 300 - 600kPa

TFS pinch valves are designed to meet tubing material, tubing size, and pressure requirements. Custom design is available even if the requirements don't fall within the specification list above.

## Molded Quaternary Valve

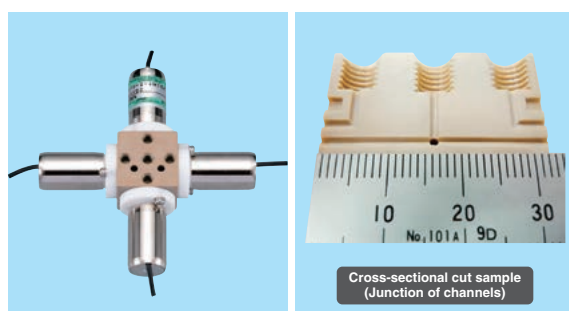

A quaternary valve, in which the four channels from the valves all join at one point and connect to the common port, requires a high processing accuracy at the junction of the channels. Thus the manifold bases of almost all conventional models, including those of other manufacturers, are manufactured by machining, which results in an increased cost. With advanced molding techniques, TFS has achieved the molding of this junction in PEEK, enabling us to provide our quaternary valves at prices conventional models cannot match.

## Chemically Inert Pinch Valve



Having threaded ports for plastic tubing, this product looks like an ordinary solenoid valve, but in fact it is a type of pinch valve that uses FKM tubing internally. The valve excels in fluid exchangeability due to its simple flow structure with almost no dead volume. Furthermore, the FKM tubing gives the valve high chemical inertness.

# Micro Pumps for Infusion

## Ultra-small Peristaltic Pump BCP/RCP Series [Under Development]

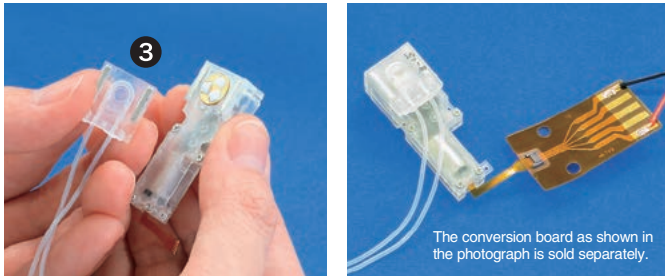
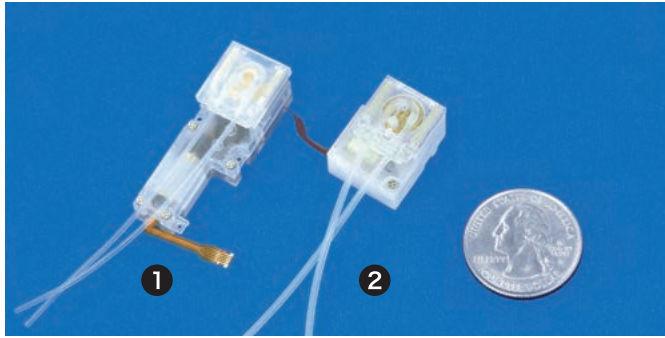

- Miniature sized!  
Suitable for wearable infusion systems.
- Control few micro litres of drugs including insulin.
- Can be battery driven (DC motor type).
- Clean and economical wetted area due to its disposability.
- Possible to customise for your required flow rate!
- Easy to remove and replace disposable part.



	① BCP-10E, ③ TC-10P	② RCP-10E, ③ TC-10P
Motor	DC Motor	Stepper Motor
Flow Rate	50 $\mu\text{L} / \text{min}$	35 $\mu\text{L} / \text{min}^*$
Voltage	2 VDC	—
Wetted Materials	Silicone	
Tubing size	I.D. 0.5 $\times$ O.D. 1.0 mm	
Dimensions	14 $\times$ 38 $\times$ 13 mm	16 $\times$ 19 $\times$ 16 mm
Weight	Approx. 6 g	
Remarks	Built-In Rotation Position Sensor	
Patent Pending		* When the pulse frequency is 2000 pps.

## Piezoelectric Micro Pumps

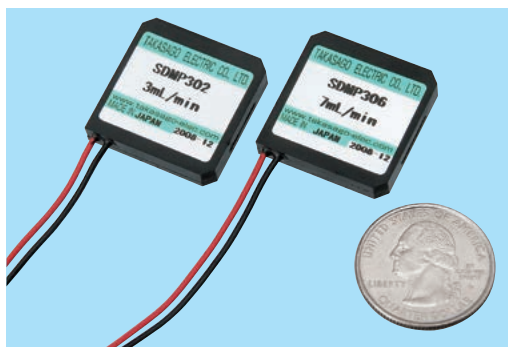

The SDMP series and the APP series are piezoelectric diaphragm micro pumps. The main features are as follows;

- Small-sized, lightweight and thin
- No metal parts in contact with fluid. The APP-20KG has particularly high chemical compatibility and can be used for wide range of fluids.
- Quiet and low power consumption
- Flow controllable by adjusting drive voltage and drive frequency
- Self-priming

The cartridge-type SDMP320C has a removable pump chamber which can be easily replaced for each fluid.

The SDMP302D/306D is the same as the SDMP302/306 but with a built-in driving circuit. When 2.5-6 VDC is applied, the pump starts operating at a fixed voltage and frequency.



	SDMP302	SDMP306	SDMP320	SDMP302D	SDMP306D	SDMP320C	APP-20KG	APP-30WKG
Type	Standard		Large Flow	Built-In Driver		Cartridge	Highly Inert	
Typical Flow Rate	3 mL / min	7 mL / min	20 mL / min	3 mL / min	7 mL / min	20 mL / min	15 mL / min	20 mL / min
Typical Pump Pressure	40 kPa	45 kPa	35 kPa	40 kPa	40 kPa	20 kPa	25 kPa	60 kPa
Voltage	60 - 250 Vp-p			—	—	60 - 250 Vp-p		
Drive Frequency	10 - 60 Hz			—	—	10 - 60 Hz		
Typical Suction Load Pressure	- 1.0 kPa							
Operating Temperature	5 - 50 $^{\circ}\text{C}$							
Wetted Materials	COC (Cyclic Olefin Copolymer), EPDM						PTFE, PEEK, FFKM	
Dimensions Weight	25 $\times$ 25 $\times$ 4.8 mm Approx. 4g		33 $\times$ 33 $\times$ 5.5 mm Approx. 9g	25 $\times$ 25 $\times$ 8.2 mm Approx. 7g		33 $\times$ 33 $\times$ 6.8 mm Approx. 13g	33 $\times$ 33 $\times$ 9 mm Approx. 17g	
Input / Output Pipes	$\phi$ 0.6 - $\phi$ 1.2 - L 2.5	$\phi$ 1.3 - $\phi$ 2.1 - L 3.5	$\phi$ 1.8 - $\phi$ 2.8 - L 5.0	$\phi$ 0.6 - $\phi$ 1.2 - L 2.5	$\phi$ 1.3 - $\phi$ 2.1 - L 3.5	$\phi$ 1.8 - $\phi$ 2.8 - L 5.0	$\phi$ 1.8 - $\phi$ 2.8 - L 5.0	

\* It is driven by a sine wave but it can also be driven by our standard wave form which will result in increase in flow rate and pump pressure.



# Drug Delivery Systems

## Chip Pump ACP/QCP Series

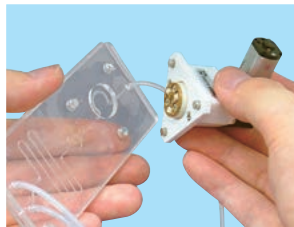
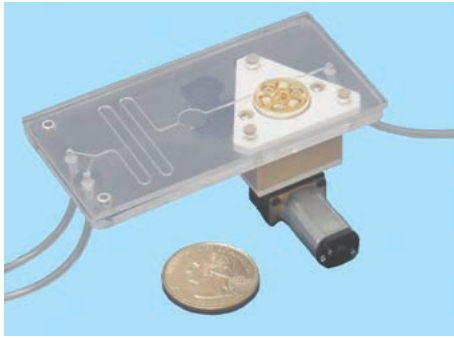

This unit incorporates a planar peristaltic pump into a PDMS chip, where rollers rotate and compress a  $\Omega$ -shaped channel to directly pump the liquid inside. The PDMS chip is replaceable and sterilisable. Flexible flow channel design is possible to include a mixing zone, reagent reservoir, waste tank, etc. in a chip.

	ACP-29	QCP-29
Motor	DC Motor	Stepper Motor *1
Flow Rate *2	55 $\mu\text{L} / \text{min}$ , 200 $\mu\text{L} / \text{min}$	1 - 165 $\mu\text{L} / \text{min}$
Operating Pressure	50 kPa	
Rated Voltage	3 VDC	
Chip Material	PDMS	

Patented

\*1 We have a controller "RE-C100" to operate these chip pumps easily.

\*2 The flow rate of the QCP series is defined when used with the controller RE-C100.

## SMP Series [Under Development]

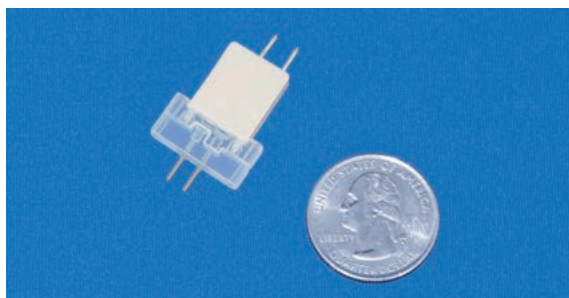

Adopting shape memory alloy as the driving source, this valve works as a drip pump with the following features :

- Ultrasmall and light weight with a thickness of 4mm
- Silent operation with no driving noise
- Low power consumption and can be powered by DC power source.

The price can also be brought down further by mass production enabling disposability without cost constraints.

Patented

## Electro-osmotic Micro Pump EBP Series

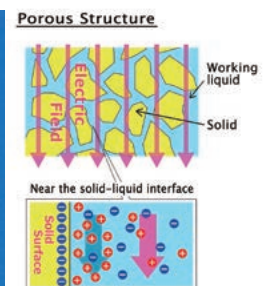
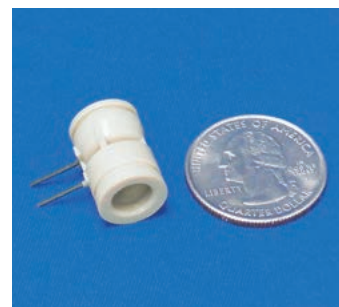

The Electro-osmotic Pump (EO pump) is an extremely small pump that uses electroendosmosis (See the flow generation principle below). Its features include a high output pressure up to 1 MPa, operation, no pulsation, extremely low power consumption and an adjustable flow proportional to the applied voltage. No operating noise is generated during its use as it has no mechanically moving parts. The flow rate is about 60  $\mu\text{L} / \text{min}$  at 150VDC and about 10  $\mu\text{L} / \text{min}$  at 24VDC (back pressure 0 kPa, when deionized water is used). It can be integrated to a microfluidic chip for delivering liquids into the chip. Indirect drive types, which utilise a diaphragm to deliver various liquids, are also available.



# Pumps Covers wide

## Tubing Pump RP-TX Series

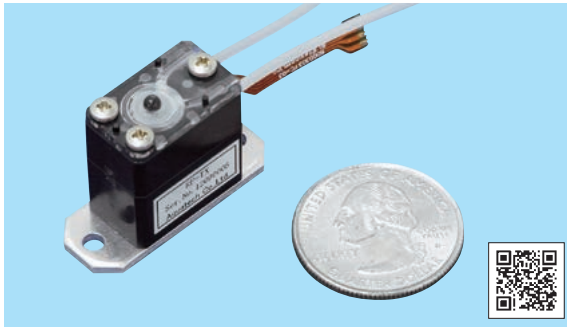

- The world's lowest level of flow for a peristaltic pump on the market: 0.1 ~ 40  $\mu\text{L}/\text{min}$
- A replaceable pump head, which includes tubing.
- Compact size: Dimensions of 33 × 12 × 21.5 mm
- An easy-to-use controller is available upon request. (Sold separately)

Discharge Rate	0.1 - 40 $\mu\text{L} / \text{min} \pm 15\%$ (Water at 25 °C, Pulse speed : 3 - 1000 pps)
Tube Material	Silicone or Olefine (I.D. 0.5 mm)
Discharge Pressure	$\geq 30$ kPa
Motor	Stepper Motor
Voltage	3 VDC
Dimensions	33 × 12 × 21.5 mm

\* This is a product of Aquatech Co., Ltd.

## Tubing Pump RP-Q II / Q III Series

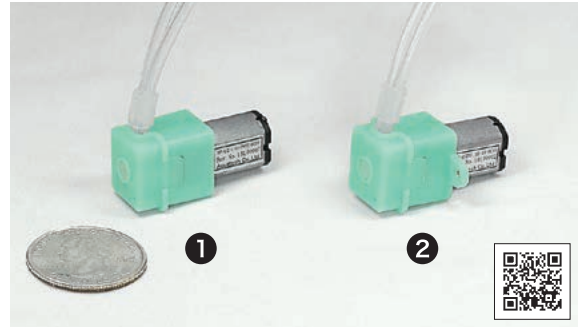

	① RP-QII & QIIX	② RP-QIII & QIIIX
Discharge Rate	0.45 - 3.00 mL / min $\pm 20\%$	
Tube Material	Silicone, SWFT	
Discharge Pressure	$\geq 50$ kPa	
Motor	DC Geared Motor	
Voltage	3 VDC	
Power Consumption	< 0.36 W	
Dimensions	15 × 17 × 32.2 mm (excluding mounting parts)	
Mounting Flange	None (optionally use mounting clip)	Equipped
Pump Head Replacement	Possible	

\* This is a product of Aquatech Co., Ltd.

## Tubing Pump RP-HX Series

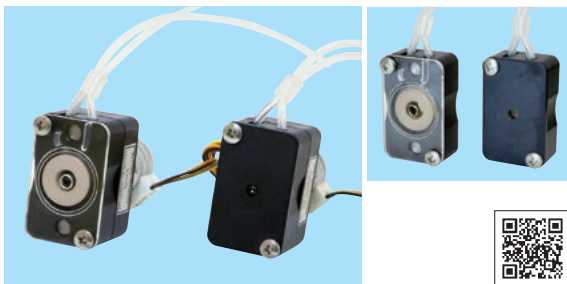

- Stepper motor control allows extremely small discharge rates.
- By using different pump heads, the pump can handle a wide range of discharge rates between 2 to 1,000  $\mu\text{L} / \text{min}$ .
- Easy pump head replacement using magnets.
- An easy-to-use controller is available upon request (Sold Separately) .
- Autoclavable pump heads are also available (Sold Separately) .

Discharge Rate	2 - 1100 $\mu\text{L} \pm 20\%$
Tube Material	Silicone or Olefine
Motor	Stepper Motor
Voltage	3 VDC
Dimensions	32 × 20 × 46 mm

\* This is a product of Aquatech Co., Ltd.

## Tubing Pump RP-G III Series

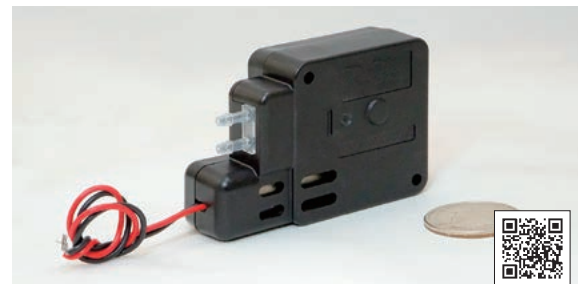

- Compact box shape and able to combine multiple RP-G III series.
- Flow rate range is on the lower end.
- TM-15 tubing is chemically resistant to many chemicals, including acetone and MEK, and suitable for ink and other chemicals.

Discharge Rate	2.5 - 12 mL / min $\pm 20\%$
Tube Material	Silicone, PharMed®, Fluran®, or TM-15®
Motor	DC Geared Motor
Voltage	3 or 6 VDC
Dimensions	22.5 × 65 × 44 mm (excluding mounting parts)

\* This is a product of Aquatech Co., Ltd.

# range of Flow Rate

## Pen Type Syringe Pump SBP Series



This is a remarkably small syringe pump with an outer diameter of 12 mm and a built-in stepper motor. The theoretical resolution is as small as 0.105 nL at 1/100 micro-step. Different needle lengths and thicknesses are available along with various port connections (ex. screws).

SBP-100G-N	
Dimensions	Dia 12 × L 165 mm (excluding needle, sensor case)
Syringe Capacity	100 $\mu$ L
Theoretical Resolution	At 1/100 Micro-Step: 0.105 nL / At Full Step: 10.5 nL
Motor	Stepper Motor
Syringe Termination*	Needle 22G (I.D. 0.40 × O.D. 0.72 × L 51 mm)
Wetted Materials	Glass, PTFE, Stainless steel

\* Various syringe terminations: needle, Luer Lock, M6 or 1/4-28UNF threads, disposable tip adapter, attachment for our ultra-small 3-way valve, etc.

## Palmtop Size Syringe Pump SCP Series

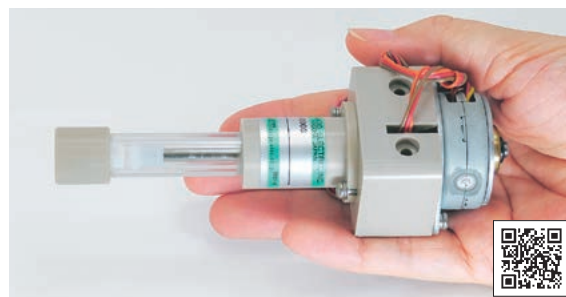

This pump with built-in motor is smaller and lighter than conventional syringe pump systems and offers reasonable pricing. It features zero dead volume when compared to similar size plunger pumps. Disposable syringe type can be developed.

	SCP-100G-1/4UF (SCP-100G-M6F)	SCP-500G-1/4UF (SCP-500G-M6F)	SCP-1000G-1/4UF (SCP-1000G-M6F)
Dimensions	35 × 42 × L 109.6 mm		
Syringe Capacity	100 $\mu$ L	500 $\mu$ L	1000 $\mu$ L
Theoretical Resolution	83 nL / pulse		
Motor	Stepper Motor		
Syringe Termination	1/4-28UNF, M6		
Wetted Materials	Glass, PTFE		

## Metering Pumps



This is a solenoid driven diaphragm metering pump. The pumped volume can be set by manually adjusting the distance of the plunger's movement in the solenoid.

- Highly Accurate Dispensing
- Simply Driven by DC Solenoid
- Adjustable Dispensing Volume
- Excels in Chemical Resistance

	① MCP-50	② PKP-500P
Pumped Volume Adjustable Range	5 - 50 $\mu$ L	50 - 500 $\mu$ L
Dimensions	30 × 26 × 63.5 mm	36 × 43 × 78 mm
Port Connection	M6, 1/4-28UNF	
Rated Voltage	12 VDC, 24 VDC	
Power Consumption	4.4 W	10 W
Wetted Materials	PP (Optionally POM, PTFE), FKM	PP (Optionally POM), FKM, Silicone

## Diaphragm Pump DBP Series



Inert diaphragm pump with flow rate of 500 mL/min. 20% higher flow than other competitive pumps of similar size, even at higher pressure ranges.

Using a diaphragm with excellent discharge performance of gas-liquid mixed fluid. DBP pumps can be used not only for liquids but also gasses. No metal materials are used as wetted parts (see table below). Suitable for a wide variety of fluids. Option to change to a longer-life motor.

Dimensions	31 × 55.2 × L 82 mm
Motor	DC Motor
Discharge Rate	500 mL / min
Rated Voltage	12 VDC, 24 VDC
Port Connection	Hose Barbs
Power Consumption	4 W
Wetted Materials	PP, EPDM



# Disposable Chips

## Microfluidic Chips

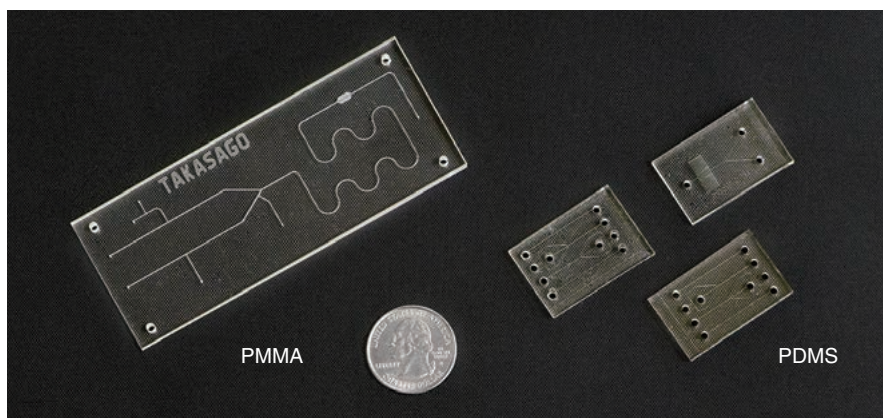

Prototypes can be made from a single sheet using materials like PMMA (acrylic), PC (polycarbonate), PDMS (silicone) etc. We can also provide fluid systems in combination with small valves, micro-pumps and micro flow meters.

	Plastic Chip	PDMS Chip
Materials	PMMA (acrylic) PC (polycarbonate) ※For other materials please consult	PDMS (silicone)
Max. Dimensions	W 90 mm × L 130 mm	Please consult with us
Thickness	- 50 mm	1.2 mm - (Open to Discussion)
Method of Manufacture	Resin Cutting → Bonding	1: Formation of simple mold → Molding → Bonding 2: Mold formation using photo resist → Molding → Bonding
Minimum Channel Width	PMMA: 0.1 mm, $\phi$ 0.2 mm PC: 0.5 mm, $\phi$ 0.5 mm ※We undertake finer flow path requirements as well	5 $\mu$ m (when manufactured using method 2) *Please feel free to contact us for more information.

## Reagent-fillable Disposable Fluidic Systems (①Roller Pump Type, ②Syringe Pump Type)

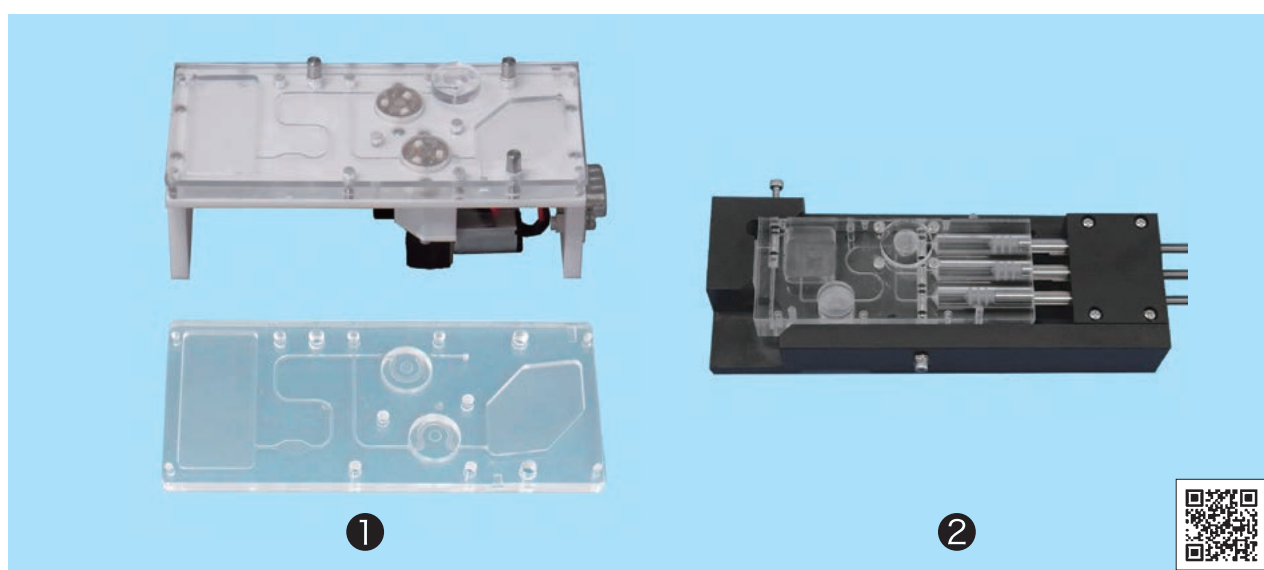

These systems integrate every necessary function of POCT into a single module. Once a reagent-prefilled module is loaded on the system, the pump discharges the prefilled reagent from the reservoir and draws a sample into the module from the sample-in port to mix them together. The module has another closed reservoir for waste, simplifying the disposal of chemicals. Time-consuming tasks are eliminated. Two types of pumps are available as shown in the above pictures: ①Roller Pump and ②Syringe Pump. Customisation is possible to match your requirements.

\* The Syringe Pump Cartridge is jointly developed with Sumigomu Takasago Integrate, Ltd.



**Australian Distributors**  
 Importers & Manufacturers  
 www.chromotech.net.au  
**HRMalytic** +61(0)3 9762 2034  
**ECH nology** Pty Ltd  
 Website NEW : www.chromalytic.net.au E-mail : info@chromotech.net.au Tel: 03 9762 2034 . . . in AUSTRALIA



# and Pump Unit

## EOP-Driven Micro Pumping Unit



The Electro-Osmotic Pump (EO pump), which employs electro-osmosis, generates no pulsation. It is ideal for pulsation-sensitive microfluidic systems. De-ionised water, methanol, or ethanol etc. can be directly pumped. To overcome this limitation, this pumping unit utilises an internal diaphragm that isolates the de-ionised etc. from the liquid to be delivered. This indirect pumping mechanism enables you to pump various liquids.

Working Liquid	De-ionised Water
Wetted Materials	PP, Silicone
Flow Rate	10 $\mu\text{L}/\text{min}$
Max. Pump Pressure	300 kPa
Pump Capacity	5 mL
Weight	Approx. 105 g (excluding liquid)

\* When the operating voltage is 24VDC

## Manually Adjustable Low Pulsation Micro Pump Unit

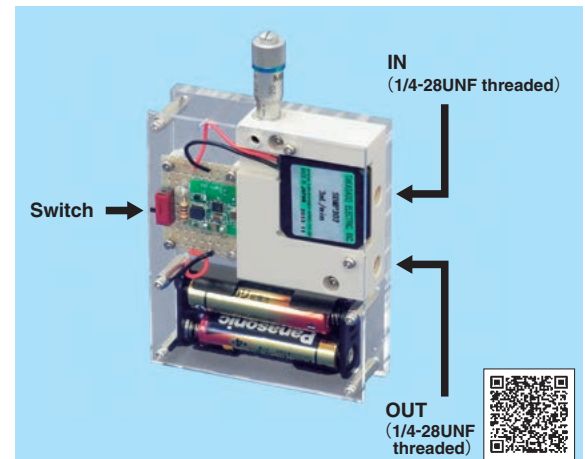

- Suitable for lab-on-a-chip devices, cell culture media circulation, etc.
- Flow from a piezoelectric micro pump is adjusted by a micro needle valve.
- Can adjust flow from sub-microliter level to 1 ml/min.
- Flow pulsation at low flow rates is drastically reduced by the micro needle valve.
- Stand-alone functionality powered by LR03 or R03 batteries.
- Compact size: Dimensions of 66 × 25 × 105 mm

## Smart Dispensing Module

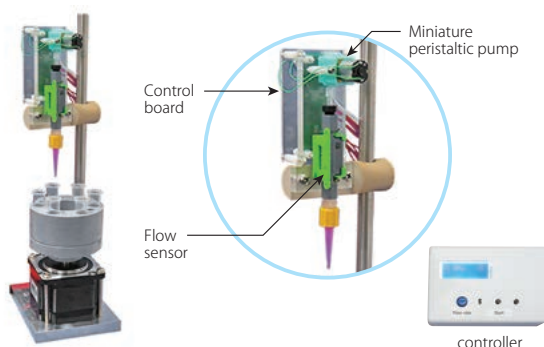

High-precision dispensing can be carried out easily even with a peristaltic pump, which has a pulsating flow. Simply enter the target dispensing volume into the controller, and the high-precision flow sensor monitors the total flow to give feedback-control to the pump. No need to control an expensive and complicated syringe pump anymore.

The control unit can be used in any combination with the various types of pumps that we offer. As an example, the ultra-small model shown in the picture above can achieve high precision of  $\pm 1\%$  with a dispensing volume of 300  $\mu\text{L}$  or more.



## Sample Injector Module [Under Development]

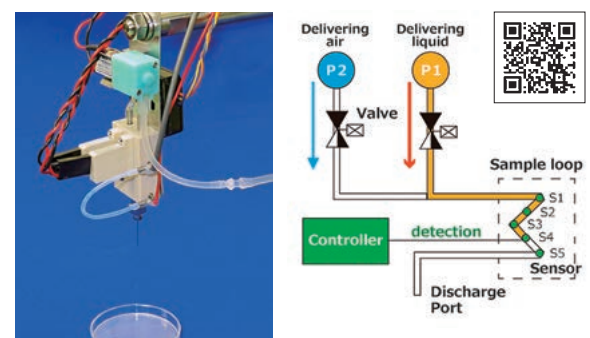

- A "flow channel extraction" type dispensing system quantifies the amount dispensed by the flow channel volume determined by the volume within the sample loop. This dispensing system uses liquid-level sensors inside the sample loop, to freely adjust the volume.
- In the flow diagram above, the liquid pump (P1) delivers the liquid until it reaches sensor 4 (S4), filling the flow channel with liquid. The air is then sent from the pump (P2), and the liquid is dispensed by pneumatic pressure. Dispensing volume can be made in steps by switching the detecting sensors (S1 - S5). Buffer can be used instead of air. The quantity and distance of sensors are customizable.
- \*Note: There may be fluids that may not be detected by liquid-level sensors. Please feel free to contact us with inquiries.
- High precision and repeatability with the fluid path volume determine the liquid volume, which is always constant.
- Different pump options can be selected to meet customer needs. For example, using a high-pressure pump to inject samples or tubing pumps to reduce cost. The picture above shows an arm-mounted type, which is compact and lightweight.

Patent Pending

## Portable Medium Replacement System



- Possible to automate medium replacement at a specified interval (12, 24, 48 or 72h).
- Works continuously in a CO<sub>2</sub> incubator, and lasts for up to 7 days with batteries.
- A standard 6-well plate is available for use in this system.
- Possible to observe the cells in plate during culture with an inverted microscope.
- All parts in contact with the medium are replaceable.
- Suitable for any application requiring frequent medium replacement such as iPS cell experiments.

Volume of Medium Exchange	2.7 mL / well
Power Supply	AC adaptor (can be customized to two AA batteries)
Wetted Materials	PP, Silicone, Stainless Steel 304
Dimensions	W 194 × D 228 × H 140 mm

Patent Pending

## Micro 3D Perfusion Culture System [Under Development]

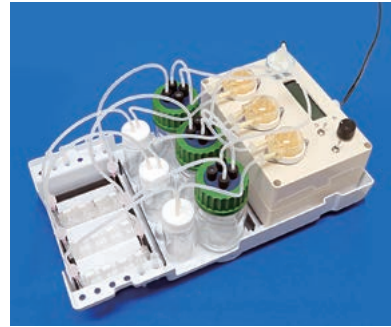

This culture system is designed for three-dimensional tissue culture of organoids and others, and the culture medium can penetrate through the tissues or cell layers like blood flow inside the specialized culture vessel (micro transwell). The liquid feed pressure can be adjusted, and the culture vessel holder can be placed on the microscope stage, which would allow for observation from the side of the micro transwell. The entire system is compact and allows easy use of perfusion culture.

Patent Pending

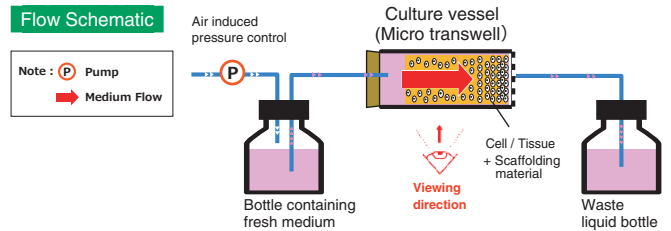

## All-in-one Disposable PDMS Chip [Under Development]

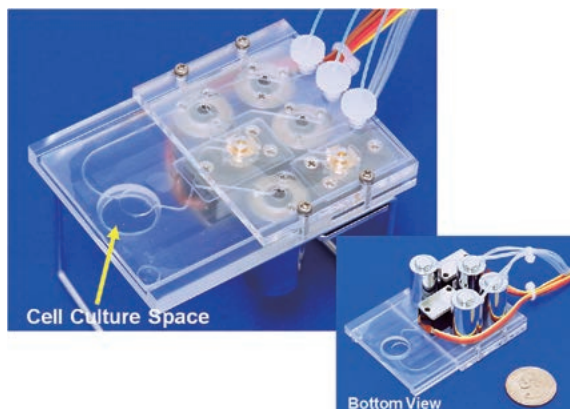

This all-in-one system on a disposable PDMS chip is a microfluidic module designed for cell culture. It has peristaltic pumps, miniature valves, and a built-in cell culture space which can be observed under a microscope. The replaceable chip is sterilizable before use. A remote controller using an Android application is available for this module upon request.

This is just an example of our integrated fluid control systems. Other microfluidic systems can be designed and manufactured in accordance with your requirements.

This system is jointly developed with Aquatech Co., Ltd. and Fukoku Bussan Co., Ltd.

## 6-channel Pump

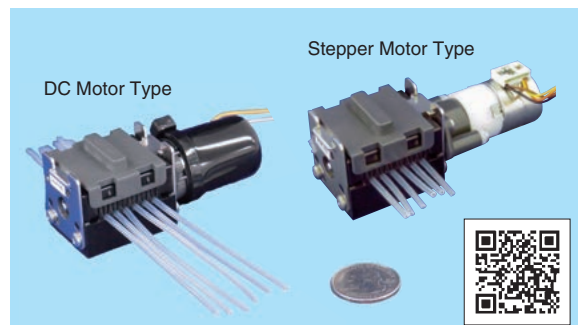

This product can deliver six separate fluids simultaneously, despite its compact size.

- The tubing is easy to replace.
- A Stepper motor model is also available, which can handle flow rates as small as 0.23  $\mu\text{L} / \text{min}$ .
- The flow rate accuracy between channels is 10% when the same tubing is used.

Motor	DC Motor	Stepper Motor
Flow Rate	830 $\mu\text{L} / \text{min}$	0.23 - 350 $\mu\text{L} / \text{min}$
Tubing Material	Silicone (1 × 2 mm)	
Discharge Pressure	30 kPa	
Voltage	3 VDC	10 VDC
Dimensions	W 31 × L 84 × H 32 mm	

# and Aerospace

## Live Cell Imaging Fluidic System Stage Top® Type

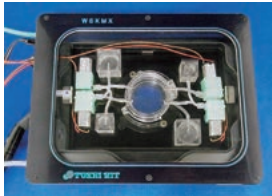

- Compact : The Pumping unit, including 4 pumps and 4 reservoirs, meets standard ANSI/SBS footprint and fits in a stage top incubator.
- Programmable: You can easily program your protocols; from rapid media exchange to gentle perfusion.
- Disposable : All parts in contact with the medium, including pump heads, nozzles and tubing, are replaceable.
- The system can be customized to meet your needs.

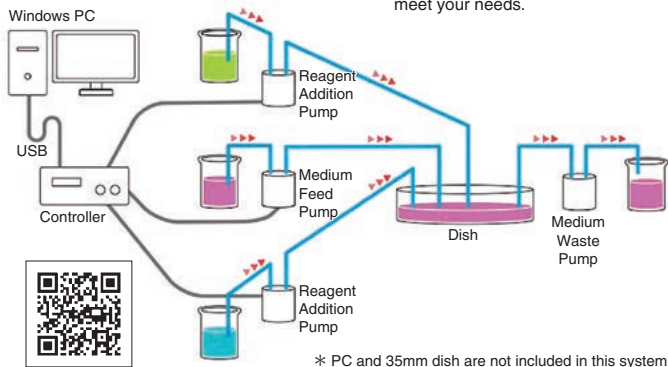

## Differentiation Induction System

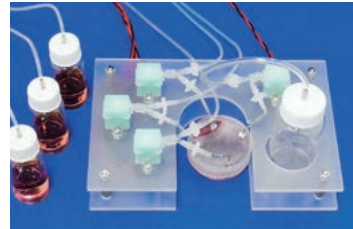

The replacement of multiple medium during differentiation of cells along with the introduction of various reagents can now be done easily through PC. Initiation of the apparatus by pressing on the start button will result in the medium and reagents being injected and discharged automatically. This system can be safely used even if the medium replacement and reagent introduction time happens to be during the night or on a holiday i.e., when the personnel may be absent. The automation paves the way for greater reproducibility of the process. This system consists of pumps (up to 8) and a controller, allows automated injection of 7 types of media and reagents. The pump unit can be stored in the incubator along with the culture dish. Automation of the transfection process can be achieved by customization.

## Valves for Satellite Propulsion System HVA / HVC / HVD Series

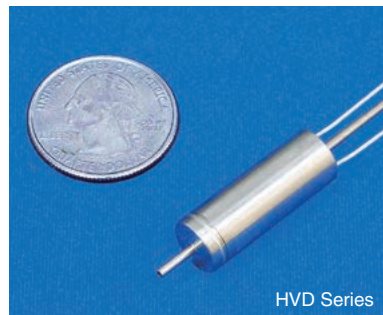
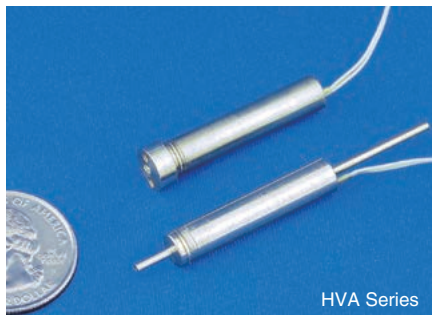

Ultra compact light weight valves which are suitable for 1 to 3 N class thrusters. The external dimensions (excluding mounting part and nipple) are  $\phi 6.2 \times L30.5$ mm for HVA Manifold Type,  $\phi 6.2 \times L31$ mm for HVA Nipple Type and  $\phi 9.5 \times 26$ mm for HVD Nipple Type. Weight only 8g for HVA and 12g for HVD. It withstands a pressure of 2MPa for HVA and 10MPa for HVD. HVA also meets the vibration test specifications of ISO19683 standards. The shape of the interface can be customized according to the requirements of the customer. We also provide a latch type working valves for both HVA/HVD.

HVA



TFS provides another model with a pressure resisting of 2.8MPa for 20N class thrusters, weighing 200 grams, without any sliding parts.

HVC







ISO9001 certified at the Japanese head office and the main factory,  
and applicable to:  
Design, development and manufacture of solenoid valves, pinch valves,  
metering pumps and associated accessories.

JIS Q 9100:2009 / AS 9100 C / EN 9100:2009 certified at the Japanese headquarters,  
and applicable to:  
Machining of parts for aviation and space industries.



Supporting Sustainable Development Goals.

## TAKASAGO ELECTRIC, INC.

URL [www.takasago-fluidics.com/](http://www.takasago-fluidics.com/)

ONLINE SHOP [takasago-elec.ocnk.net](http://takasago-elec.ocnk.net)

Chip Mart [www.microfluidic-chipmart.jp](http://www.microfluidic-chipmart.jp)

### HEAD OFFICE

66 KAKITSUBATA NARUMI-CHO, MIDORI-KU,  
NAGOYA, 458-8522 JAPAN  
TEL: +81-52-891-2301 FAX: +81-52-891-7386

✉ [info@takasago-elec.co.jp](mailto:info@takasago-elec.co.jp)

### U.S. BRANCH (d/b/a:TAKASAGO FLUIDIC SYSTEMS)



1900 West Park Drive, Suite 280, Westborough, MA 01581 U.S.A.  
TEL: +1 508 983 1434 FAX: +1 508 983 1401

【 Corporate Video 】  
Problem solving skills  
the world relies on.



【 Product Videos 】



Printed in Japan 2021.07